



Y5HOME
BUILDING A UNIQUE WORLD

Installation Guide

Y5Home 5 Module Switch



Configure Switchboard Module

Note: Switchboard module MUST be configured into Y5Box before installing it behind the switchboard panel

Follow the below mentioned steps to connect the switchboard module with Y5Box using the Y5Home App:

- Open Y5Home App (in mobile, desktop or TV)
(`<ip address:3030>` for Y5Home browser link)
- Click on “Y5Home Smart Automation” widget on homepage
- Click on “CONFIG MODULES” tab
- Check “Module Config” check box
- Add 16 char module ID in module id field (You can see 16 char module id address on switchboard module as a barcode)
E.g. 01234567ABCDEF01
- Click on “Configure” button
- After few seconds module will be displayed with red icon

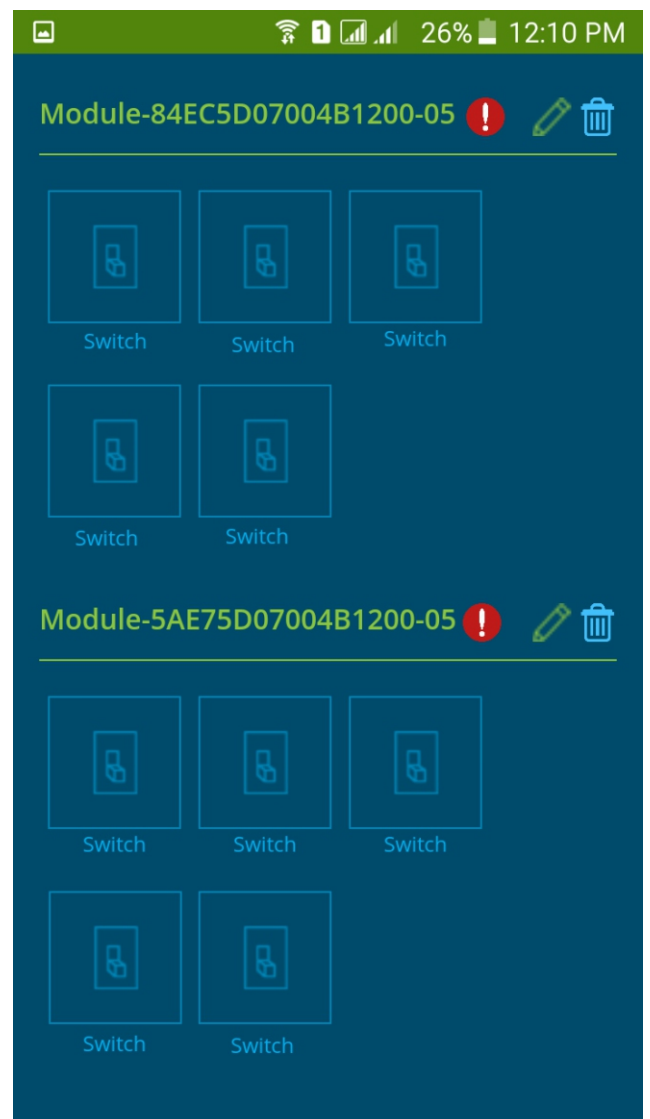

- Now you can install the Y5 Switchboard Module behind the switchboard panel
- After few minutes red icon will be disappear and module will be ready to use

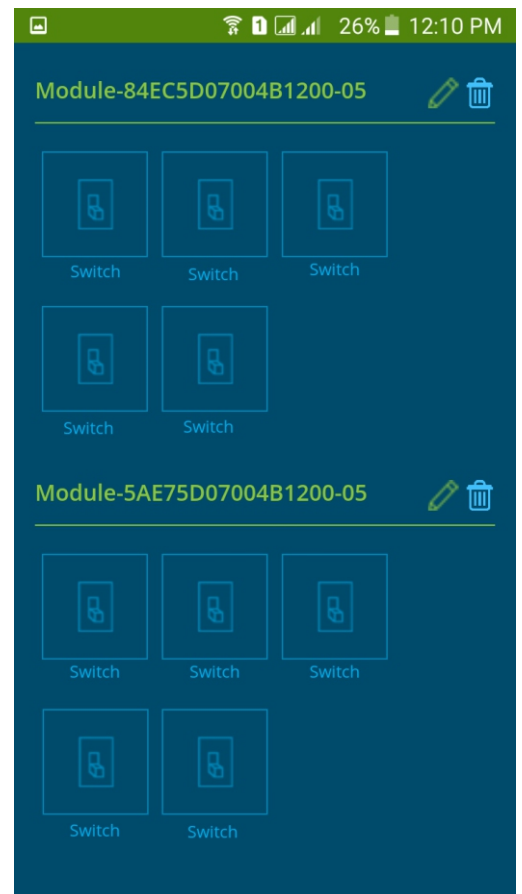

Wiring Basics

- Y5-05 module supports dimmable device on 1st switch only
- All 5 devices must have the same power source, i.e. they should all be either on municipal power, UPS or generator

Y5-04	Dimmer	Load	Devices
1st Switch	Yes	300W	Bulb, Fan
2nd Switch	No	1500W	TV, CFL, Tube Light, Table Fan etc.
3rd Switch	No	1500W	Lamp, Mosquito Coil etc.
4th Switch	No	1500W	LCD TV, Air cooler, Music System etc.
5th Switch	No	1500W	Water purifier, Fridge, Washing Machine etc.

Note: If you are not confident of handling electric wires, you can call Y5Home affiliate or your local electrician

Rating of each load is specified in above table. Y5Home is not responsible for damages done by devices with higher rating installed on load

Wiring Connections

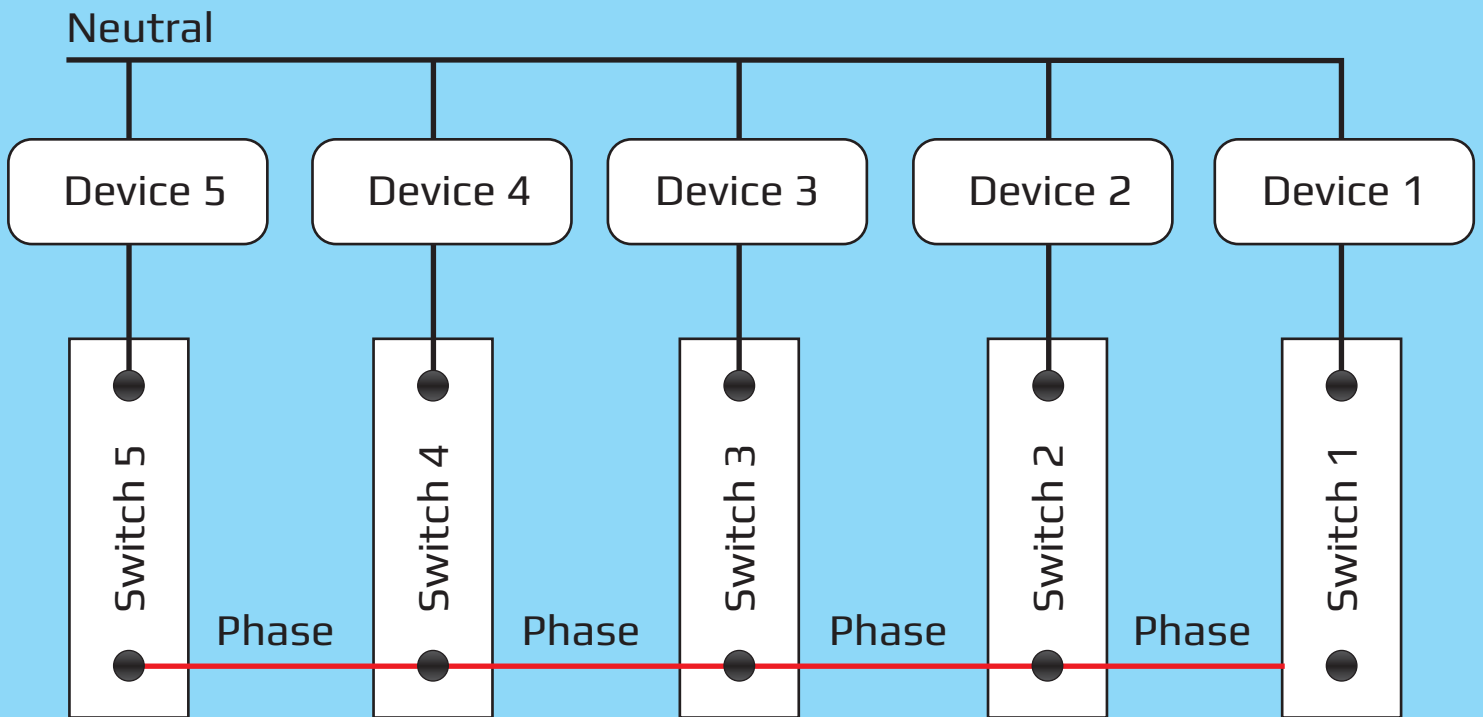

Before Installation

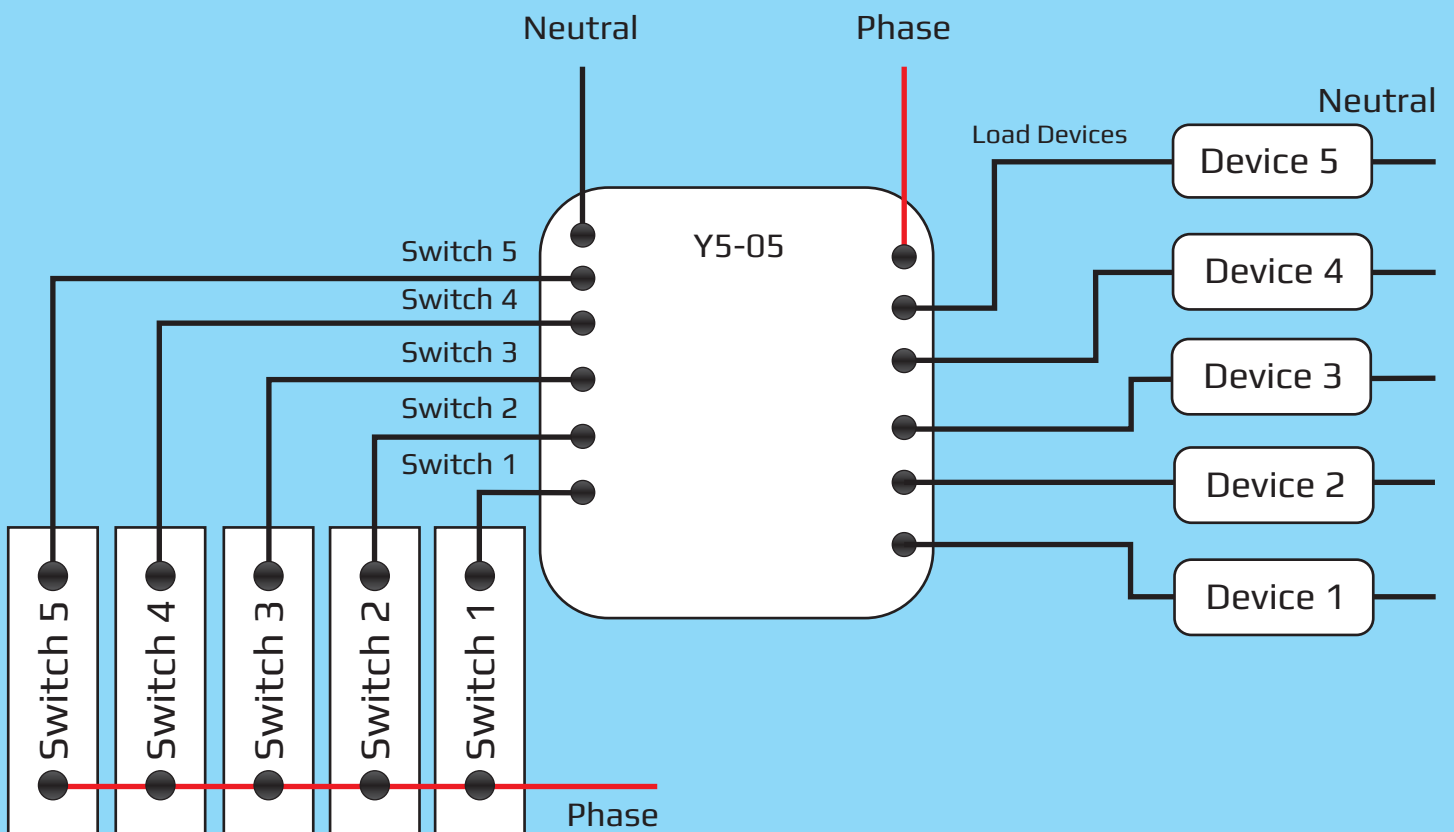

After Installation

Installation of Fan With Y5-05 - 1st Switch

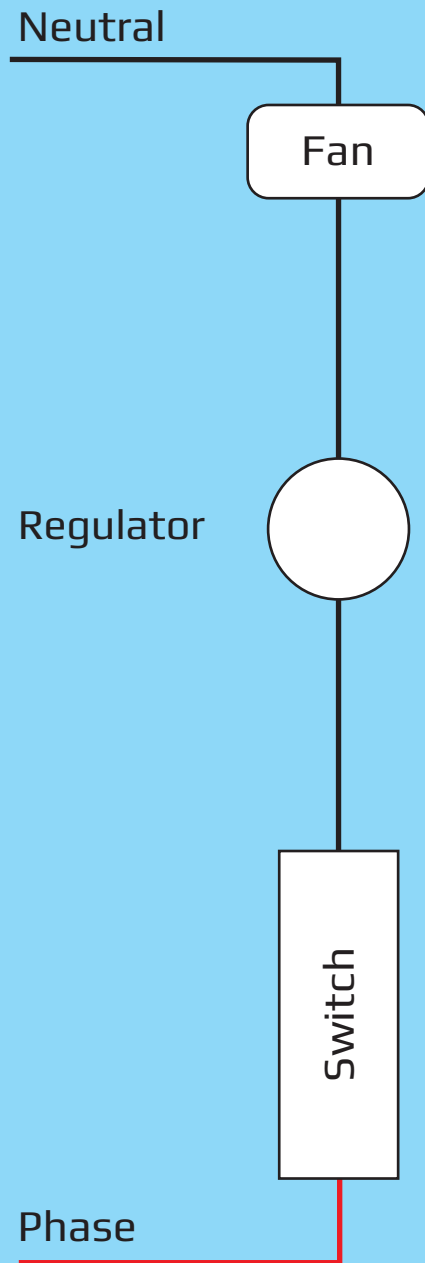

Before Installation

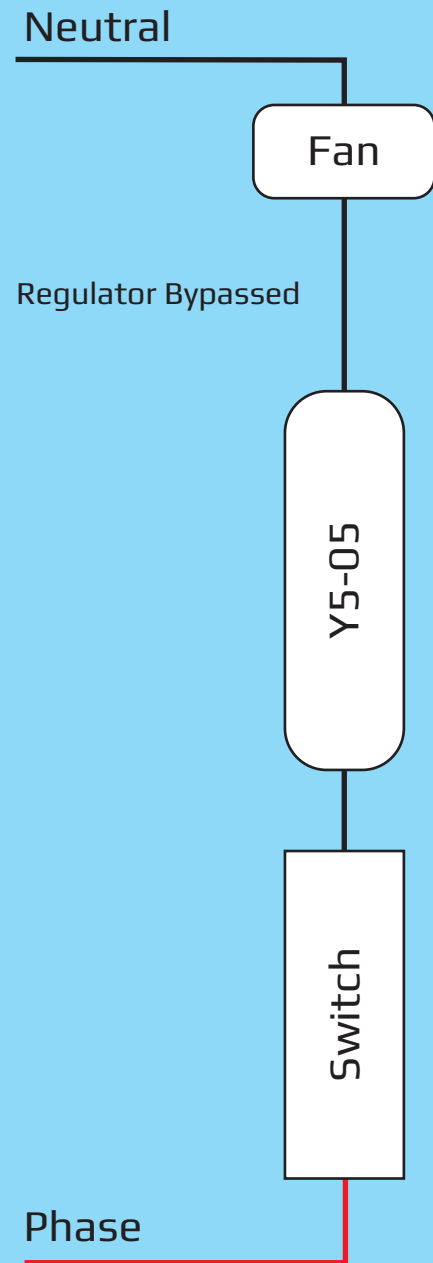

After Installation

Installation with 2-way switches



Before Installation

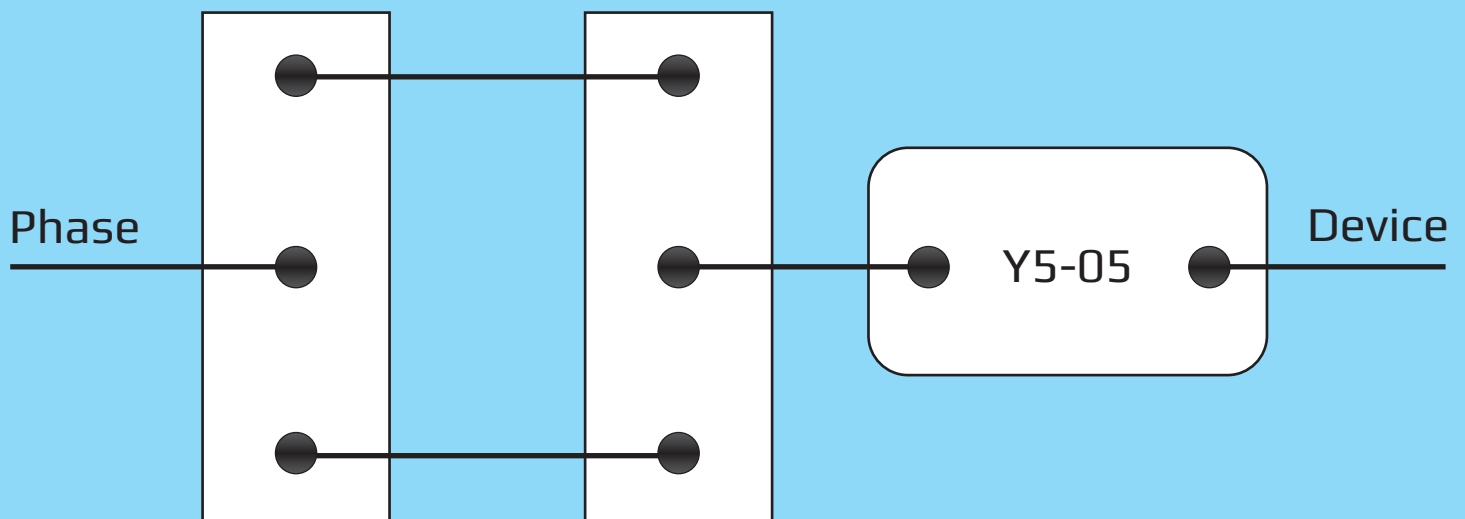

After Installation